

iKURV

Docking Station Speaker



SPEAKAL

USER GUIDE

Thank You!

Thank you for purchasing Speakal's iKurv Docking Station Speaker. We hope you enjoy using it as much as we did developing it!

You will find in this small but mighty speaker system a way to enjoy the best of your iPod or iPhone device in a very easy way.

This guide will help you understand the features of the iKurv. Please make sure you keep this for any future reference.

For more information, updates and warranty activation for your product please register your purchase at <http://www.speakal.com/register>

Contents

Safety Information	3-7
Box contents	8-9
Control buttons on speaker.....	10-11
Product Features.....	12
Remote control.....	13-14
Troubleshooting	15-16

Safety Information

WARNING: The device shall not be exposed to dripping or splashing, and objects filled with liquids, such as vases, shall not be placed on the device. As with any electronic products, take care not to spill liquids into any part of the system. Liquids can cause a failure and/or a fire hazard.

CAUTION: To reduce the risk of electric shock, do not disassemble this product. Refer servicing to qualified service personnel.

CAUTION: To prevent electric shock, match the wide blade of the line cord plug to the wide slot of the AC (mains) receptacle. Insert the full length of the plug into the electrical outlet.

WARNING: Keep the remote control battery away from children. It may cause a fire or chemical burn if mishandled. Do not recharge, disassemble, heat above 100°C (212°F), or incinerate. Dispose of used batteries promptly. Replace only with a battery of the correct type and model number.

WARNING: Do not expose the device to flames such as lighted candles

WARNING: Please take the time to follow the instructions in this owner's guide carefully. It will help you set up and operate your system properly and enjoy all of its advanced features. Please save this owner's guide for future reference. Please read these instructions for all components before using this product. Keep these instructions for future reference.

1. Heed all warnings on the product and in the owner's guide.
2. Follow all instructions.
3. Do not use this device near water or moisture – Do not use this product near a bathtub, washbowl, kitchen sink, laundry tub, in a wet basement, near a swimming pool, or anywhere else that water or moisture are present.
4. Clean only with dry cloth. Unplug this product from the wall outlet before cleaning.

5. Do not block any ventilation openings. Install in accordance with the manufacturer's instructions – To ensure reliable operation of the product and to protect it from overheating, put the product in a position and location that will not interfere with its proper ventilation. For example, do not place the product on a bed, sofa, or similar surface that may block the ventilation openings. Do not put it in a built-in system, such as a bookcase or cabinet that may keep air from flowing through its ventilation openings.
6. Do not install near any heat sources, such as radiators, heat registers, stoves or other device (including amplifiers) that produce heat.
7. Protect the power cord from being walked on or pinched, particularly at plugs, convenience receptacles, and the point where they exit from the device.
8. Only use attachments/accessories specified by the manufacturer.

9. To prevent damage, unplug this device during lightning storms or when unused for long periods of Refer all servicing to qualified service personnel Servicing is required when the device has been damaged in any way: such as power supply cord or plug is damaged; liquid has been spilled or objects have fallen into the device; the device has been exposed to rain or moisture, does not operate normally, or has been dropped – Do not attempt to service this product yourself. Opening or removing covers may expose you to dangerous voltages or other hazards. Please call service center near you.
10. To prevent risk of fire or electric shock, avoid overloading wall outlets, extension cords, or integral convenience receptacles.
11. Do not let objects or liquids enter the product – as they may touch dangerous voltage points or short out parts that could result in a fire or electric shock.
12. Use proper power sources – Plug the product into a

proper power source, as described in the operating instructions or as marked on the product.

Box Contents:

No.1: IKV-BLK-01	1PC
No.2: Remote control	1PC
No.3: 3.5mm audio cable	1PC
No.4: iPod dock adapters	7PCS
No.5: AC Adapter	1PC
No.6: Manual	1PC

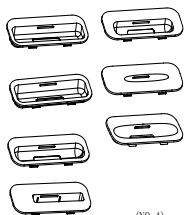

(NO. 4)



(NO. 3)

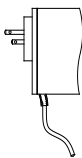

(NO. 5)

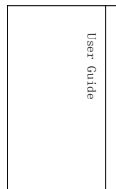

(NO. 6)

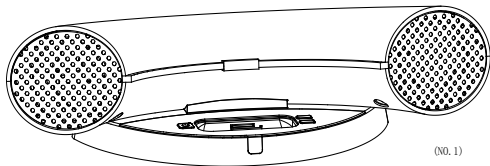



(NO. 1)



(NO. 2)

iKurv Controls

- ① Power: When it is on Standby status, press bottom  to turn system on, press this button once again to turn system off.
- ② Press button  to increase volume.
- ③ Press button  to decrease volume.
- ④ Power indicator light: when it is blue, it means this audio is power on.
- ⑤ Receive Window: to receive information on remote control.
- ⑥ Audio signal input interface: interface for other music signal.
- ⑦ Video out. When ipod or iphone in video playing status, you can connect your device to a screen with video input connect, then the video can play on the TV.
- ⑧ Power input: DC9V 1.2A.

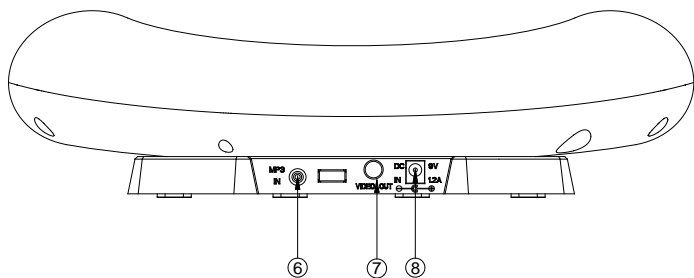
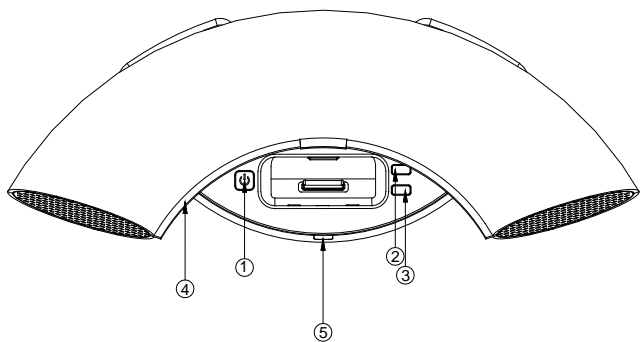

Remote Control Functions:

- A. Turn power on/off
- B. Control iPod function at the iPod mode
- C. Press this button to go up in menu
- D. Press this button to control volume down
- E. Press this button to play music with its own system
- F. Press this button to go down in menu
- G. Press this button to choose back in iPod
- H. Press this button to play/stop in iPod
- I. Press this button to next in iPod
- J. Loop all
- K. Ok
- L. Press this button to control volume up
- M. Press this button to change and choose iPod /iphone and AUX
- N. Press to mute, press again for sound
- O. Press this button to control LED 4 levels brightness

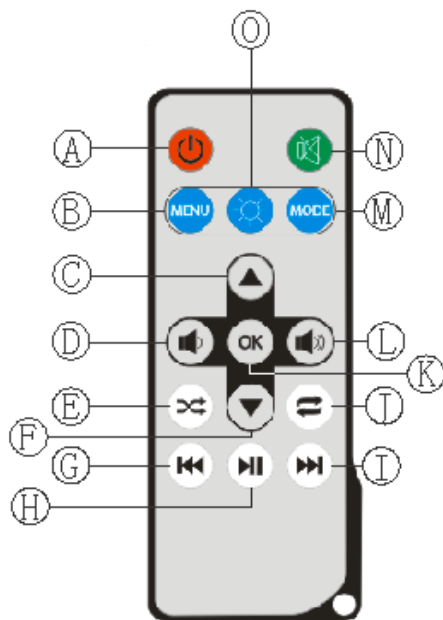

Troubleshooting

PROBLEM	WHAT TO DO
---------	------------

iPod can't put into the iPod dock	<ol style="list-style-type: none">1. Please choose the corresponding iPod connectors from the accessories in the box for your iPod
-----------------------------------	--

No sound	<ol style="list-style-type: none">2. Make sure the player is connected with the audio rightly3. Make sure the player is playing well4. Turn the volume up, and check the player's volume output is working well.5. Make sure the playing mode is corresponding with player
----------	---

<p>Remote control is inconsistent or does not work</p>	<ol style="list-style-type: none">1. Make sure the remote control's signal was sent to the audio2. There are some things which interfere with control signals between the audio and remote control3. Operate the remote control closer to the unit, if it works that means the remote control battery is lack of, please replace the battery
--	--



SPEAKAL

5555 Inglewood Blvd., Suite 204
Culver City, CA 90230
310.301.0106
www.speakal.com

The Trademark Speakal and all the developed products with this label are registered patents and belong to Egy Handel.

Our company reserves all rights and not allow reprinting of this catalog or any of its materials. Other concerned trademarks all belong to their proprietors.

As to the constant update and development of the products, our company reserves the right to change and rework out products without notice.